

TSP5L80SP

-NOV-201

7 U H Q F K 0 2 6 % D U U L H U 6 F K R W W N

Features

TSP5L80SP

TO-277



Applications

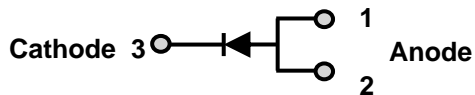

Maximum ratings and electrical characteristics (T_J = 25°C unless otherwise noted)

				8	
				8	
				5	
7 \ S L F D O W K H U P D O U H V L V W D Q F H S H U		G B R J C H 0 R X Q W H G R Q) 5		3 & %	
		7 - f &		MAX.	
				0.	
				-	
				0.7	
				8	
				5	0

(1) Pulse test: 300 μs pulse width, 1 % duty cycle

(2) Pulse test: Pulse width 0.40 ms

TSP5L80SP

-NOV-201

RATINGS AND CHARACTERISTICS CURVES (TA = 25 °C unless otherwise noted)

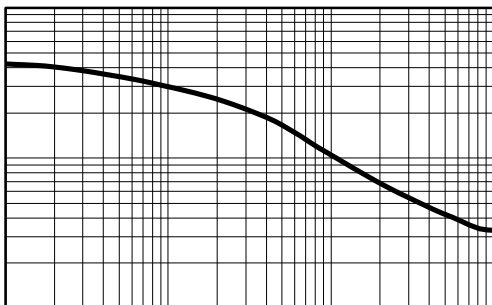
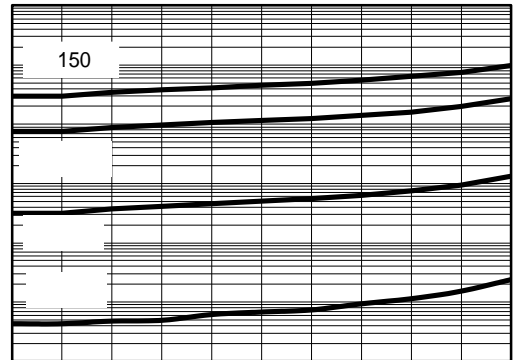
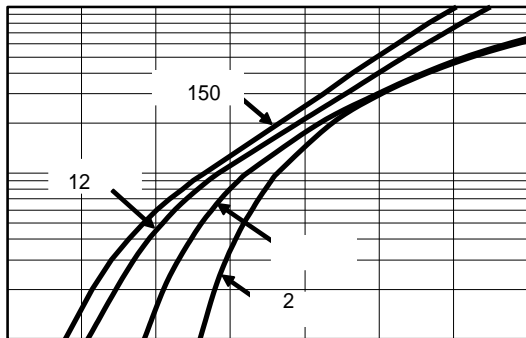
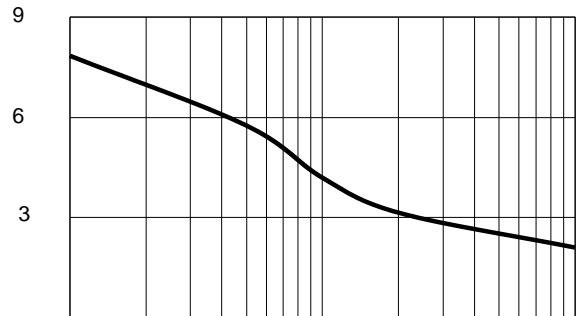
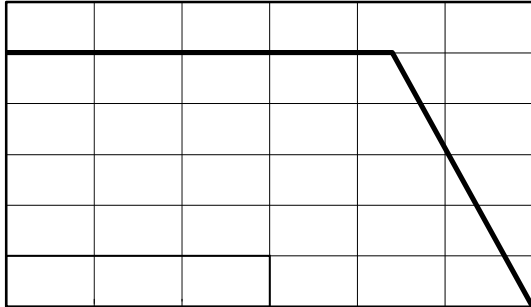

TSP5L80SP

-NOV-201

PACKAGE OUTLINE DIMENSIONS

TO-277

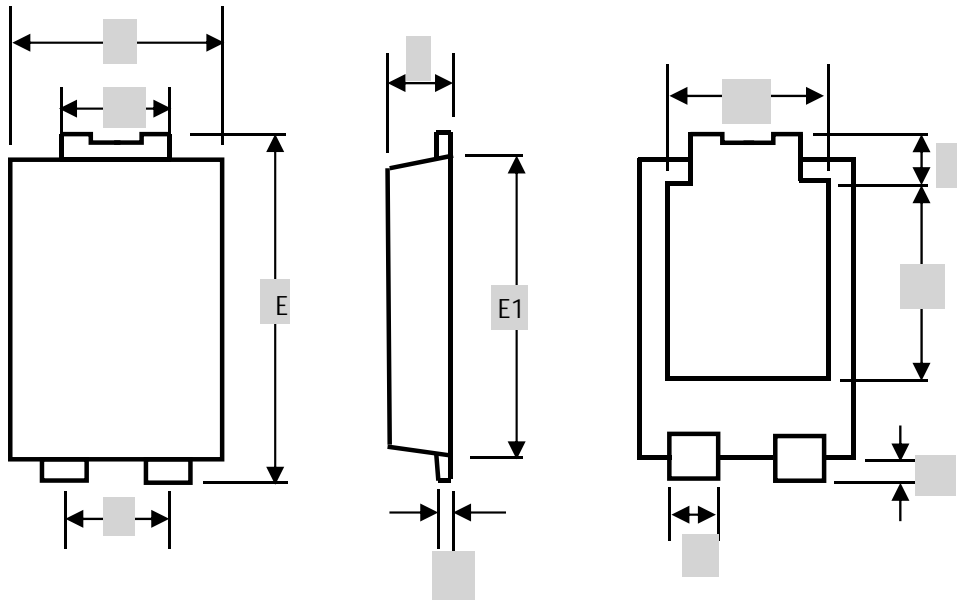

TO-277 mechanical data

TO-277 Suggested Pad Layout

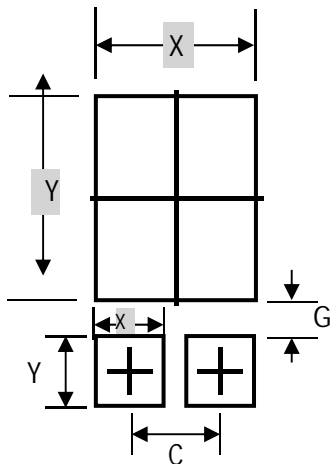

		C	G	X	X1	Y	Y1
		18	09	34	1.4	4.9	1.4
		78.86	35.43	133.86		192.91	55.12

Marking Information

/ 8

/ 8

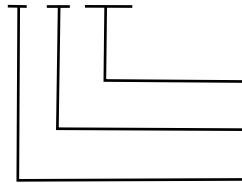
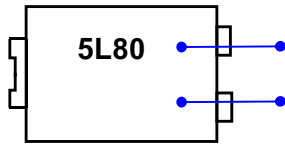

Packaging Information

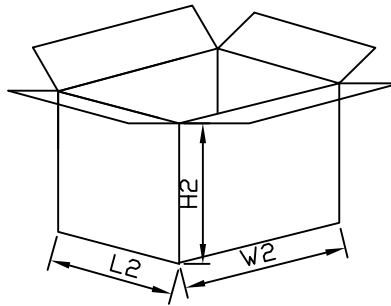
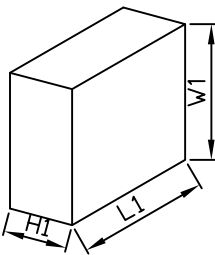
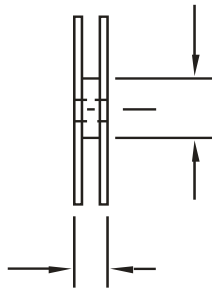
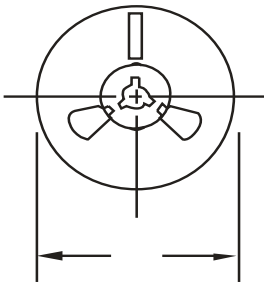

Packaging Information