

7UHQFK 026 %DUULHU 6FKRWWN\ 5H

763 9 63
TO-277

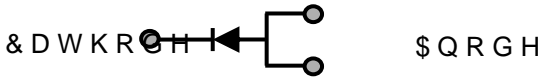

)HDWXUHV
 ‡ \$GYDQWUHQFK WHFKQRORJ\
 ‡ /RZRUZVROWDJH GURS
 ‡ /RZRZURVVHV
 ‡ +LJHILFLHQF\ RSHUDWLRQ
 ‡ /HDGH)HLQLVK &RPSOLDQW

\$SSOLFDFWLRQV
 ‡ '&' &RQYHUWHUV
 ‡ \$\$ '&\$GDSWRUV
 ‡ 6ZLWFKRZHXSSOLHV
 ‡)UHHZKHHLRGLJ

0D[LPXP UDWLQJV DQG HOHFWULFDJ& FXODDWHVHUQRWHV

3DUDPHWHU		6\PERO	/LPLW	8QLW
0D[LPXPVSHUNYHYURQWDJH		9550		9
0D[LPXPYHURJHZDUG UFXEWHIQWG		,) \$9		\$
3HDN IRVZDUEBUUHQW VLKDDHQZDYH VXSHULP&NDVHRS&GLRGH		,) 60	0	\$
2SHUDMXQDQCRQWRUDJH WDESHUDW XOH 767			WR	f &
7\SLFDO WKHUPDO UHVLVWDQFH SHU		GLS&H	ORXQWHG RQ)5	3&f% :
,QVWDQWDQHRROWRUJZDUG SHGLRGH	,) \$	7- f &	7 < 3	0\$;
	,) \$	7- f &		
	,) \$	7- f &		8
	,) \$	7- f &		
,QVWDQWDQHRXUUSHOMRQWH UDWHYHYURQWDJH		7- f &		X\$
		7- f &	5	P\$

1RWHV
 3XOVH WHVVSXOVH ZLGWK GXW\ F\FOH
 3XOVH WHVW 3XOPH ZLGWK 0

5\$7,1*6 \$1' &+\$5\$&7(5,67,&6 &7859(6f& XQOHVQRWKB UZLVH

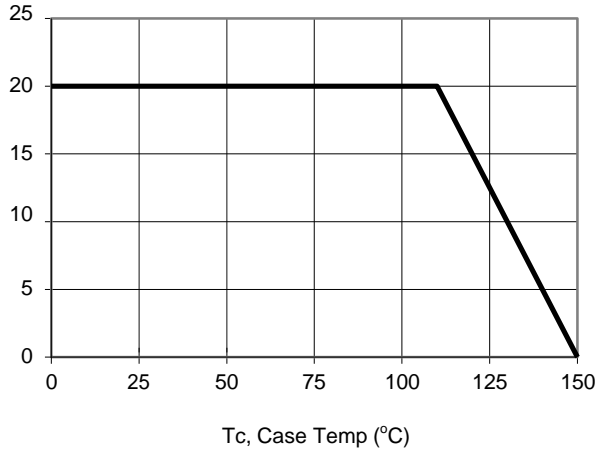

& D S D F L W S D Q F H

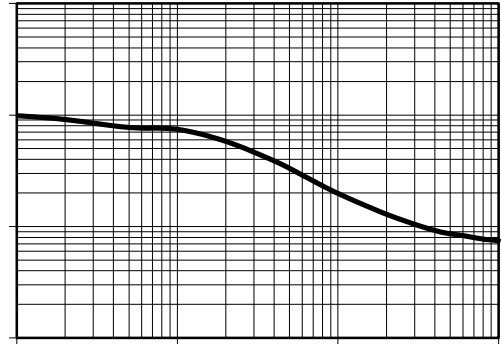

Reverse Voltage (V)

, I , Q V W D Q W J R Q Z B X X Q U U \$ Q W

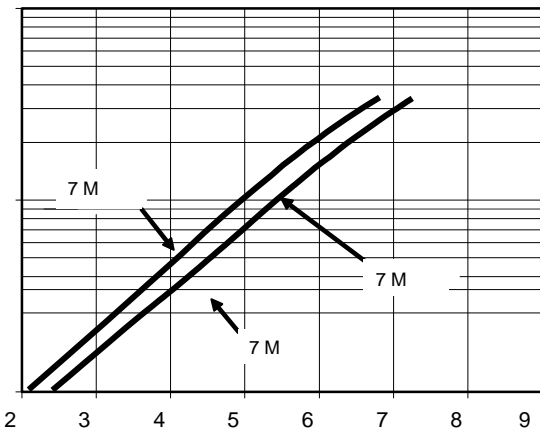

, U 5 H Y H U V V H X \$ X U U H Q W

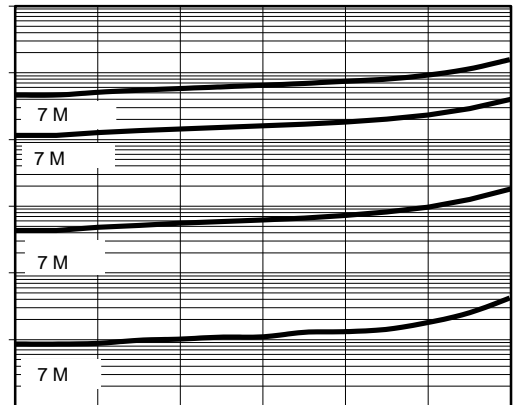

91 , Q V W D Q W D Q H R X V) R U Z D U G 9 R O W D J H P 9 5 5 H Y H U V V H 9 R O W D J H 9 R O W V

3 \$ & . \$ * (287 / , 1 (' , 0 (16 , 2 16

TO-277

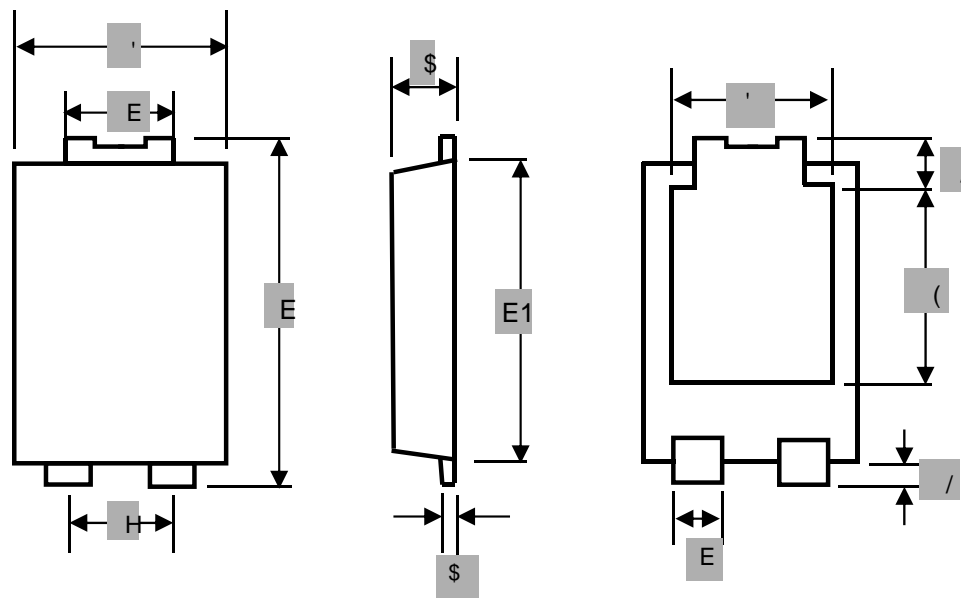

72 M H F K D Q D B W O

81,7		\$	\$	E	E	'	'	(((/	/
PP	PD[
	PLQ											
PLO	PD[
	PLQ											

72 6 X J J H V W D H G \ R X W

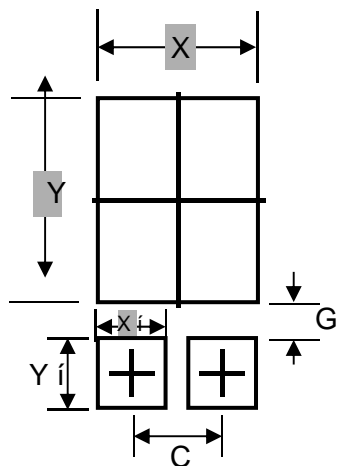

81,7		&	*	;	;	<	<
PP	PLQ						
PLO	PLQ						

0DUNLQJ ,QIRUPDWLRQ

73URGXFW PRGHO 75BIHUUU63
WR DV 9

83' & LQIRUPDWLRQ

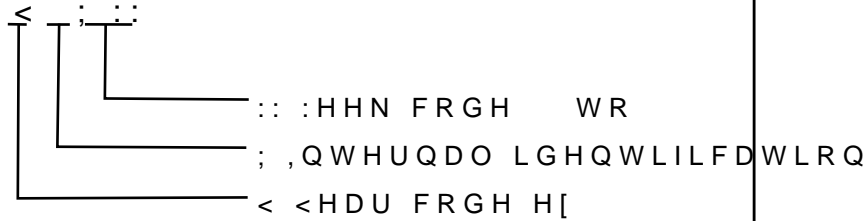
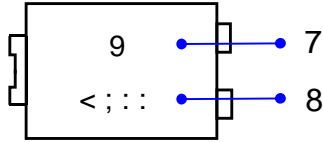

3DFNDJLQJ ,QIRUPDWLRQ

5HHO 'LPHQVLRQV

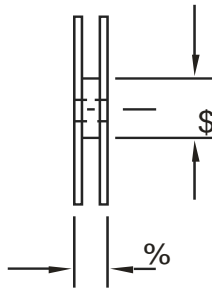
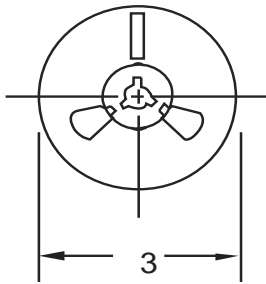

,QVLGH %R[

2XWVLGH %R[

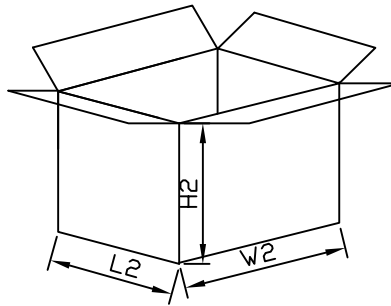
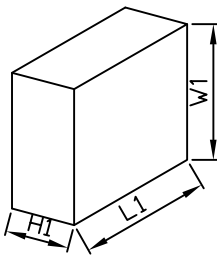

3DFNDJLQJ ,QIRUPDWLRQ

12	81,7	5HHO'PHQVLRQV			,QVLGH %R[2XWVLGH %R[
		&	\$	%	/	:	+	/	:	+
6L]H	PP									
47<	3&6	6PDOOHVW SDFNDJH			3&6 UHHO			3&6 UHHO		
1RWH		7ROHUDQFPP" PP			PP" PP			PP" PP		