

7UHQFK 026 %DUULHU 6FKRWWN\ 5H

763 / 63  
TO-277

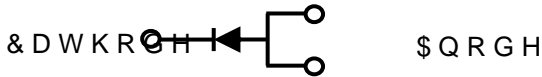

)HDWXUHV  
 ‡ \$GYDQWUHQFK WHFKQRORJ\  
 ‡ /RZRUZVROWDJH GURS  
 ‡ /RZRZURVVHV  
 ‡ +LJHILFLHQF\ RSHUDWLRQ  
 ‡ /HDGH)HLQLVK &RPSOLDQW

\$SSOLFDWLRQV  
 ‡ '& '& &RQYHUWHUV  
 ‡ \$\$ '&\$GDSWRUV  
 ‡ 6ZLWFKRZHSXSSOLHV  
 ‡ )UHHZKHHLRGLQJ

0D[LPXP UDWLQJV DQG HOHFWULFDJ& FXODDWHVHUQRWHIGFV

3DUDPHWHU		6\PERO	/LPLW	8QLW
0D[LPXPHSHVSHUNYHYURQWDJH		9550		9
0D[LPXPYHURJHZDUG UFKWUHQWG		,) \$9		\$
3HDN IRUZDUEBUUHQW VLQDQHQZDYH VXSHULPSQDWHGRSGLRGH		,)60		\$
2SHUDMXQDQGRWRUDJH WDRSHUDW		XUH 767	WR	f&
7\SLFDO WKHUPDO UHVLVWDQFH SHU		GLRSH ORXQWHG RQ )5		3&f% :
,QVWDQWDQHRROWRUJZDUG SHGLRGH	,) \$	7- f&	7<3	0\$;
	,) \$	7- f&		
	,) \$	7- f&		
	,) \$	7- f&		
,QVWDQWDQHRXUUSHQWUHQW UDWHYHYURQWDJH		7- f&		X\$
		7- f&		P\$

1RWHV  
 3XOVH WHVVSXOVH ZLGWK GXW\ F\FOH  
 3XOVH WHVW 3XOVH ZLGWK 0

5 \$ 7,1 \* 6 \$ 1' & + \$ 5 \$ & 7 (5,67, & 6 & 7 5 9 (6 f & X Q O H V Q R W K B U Z L V H

, I, \$ Y H U D R W Z D R X C U U H \$ Q W

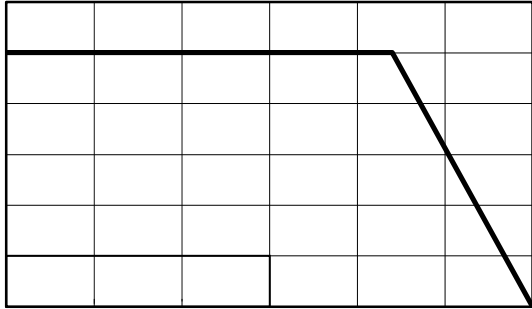

7 F & D V H 7 & H P S

Current Derating, Case

3 H D ) R U Z D R X C U U H \$ Q W

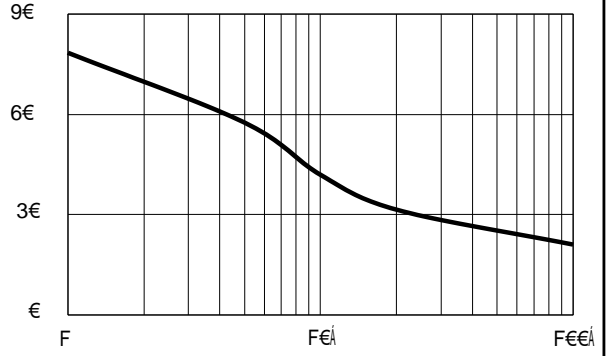

P ~ { a ^ i A [ - i O ^ & | ^ a o c i 6 € i P : A

Maximum Repetitive Surge Current

, I, Q V W D Q W J R O U Z F R X C U U H \$ Q W

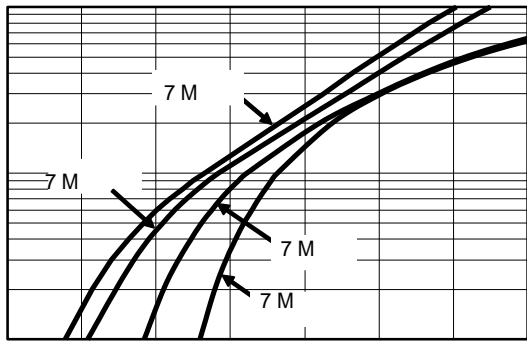

9 I , Q V W D Q W D Q H R X V ) R U Z D U G 9 R O W D J H P 9

Typical Forward Voltage

, U 5 H Y H U & X H U U H X \$ W

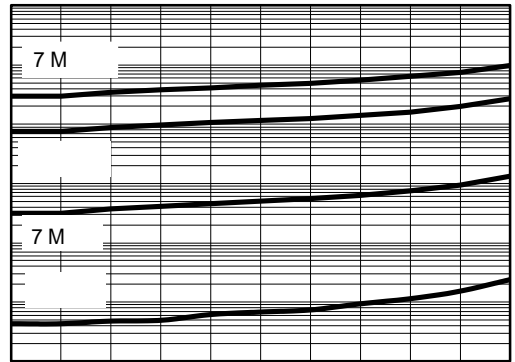

9 5 5 H Y H U V H 9 R O W D J H

Typical Reverse Current

& D S D F L W S D Q Q F H

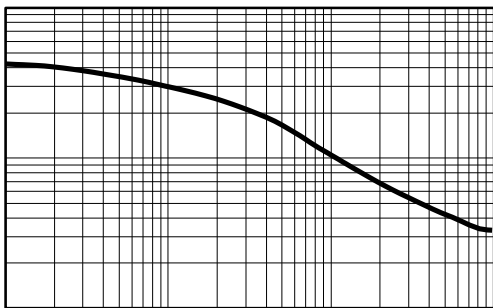

5 H Y H Q R Q H W Q J

Typical Junction Capacitance

3\$&.\$\*( 287/,1( ',0(16,216

72

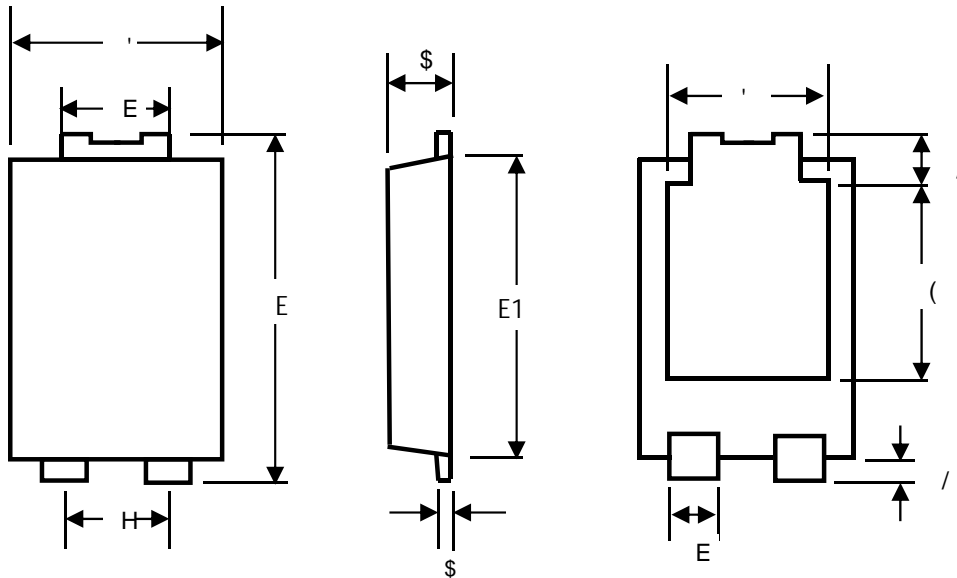

72 PHFKDQLFDO GDWD

81,7		\$	\$	E	E	'	'	(	(	(	/	/
PP	PD[											
	PLQ											
PLO	PD[											
	PLQ											

72 6XJJHVWDHGD\RXW

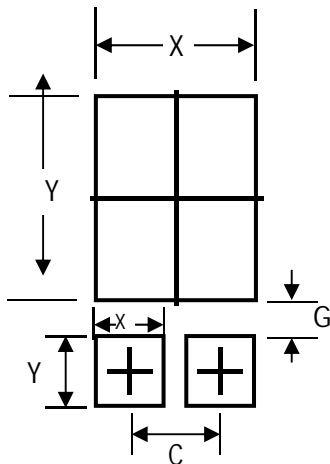

81,7		&	*	;	;		
PP	PLQ						
PLO	PLQ						

0DUNLQJ ,QIRUPDWLRQ

3URGXFW PRGHO 763 / 63 5H HUU  
WR DV /

3' & LQIRUPDWLRQ

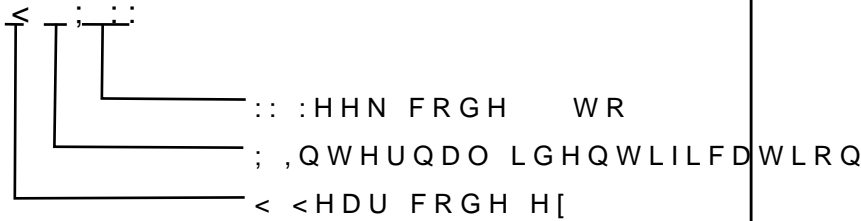
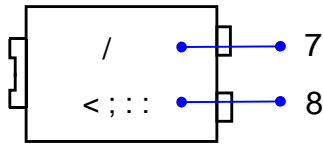

3DFNDJLQJ ,QIRUPDWLRQ

5HHO 'LPHQVLRQV

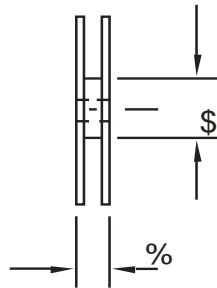
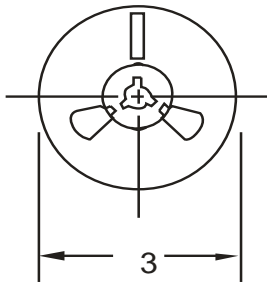

,QVLGH %R[

2XWVLGH %R[

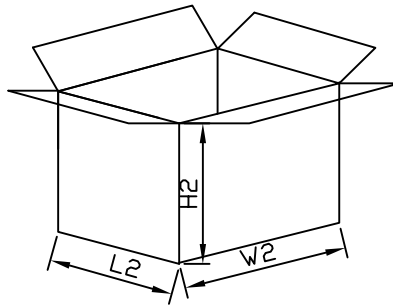
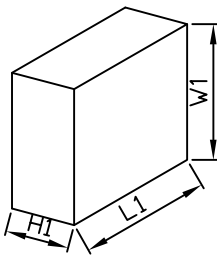

3DFNDJLQJ ,QIRUPDWLRQ

12	81,	5HHO 'LPHQVLRQV			,QVLGH %R[			2XWVLGH %R[		
		&	\$	%	/	:	+	/	:	+
6L]H	PP									
47<	3&6	6PDOOHVW SDFNDJH			3&6 UHHO			3&63&6HFFOVRQWRWDO		
1RWH		7ROHUDQFHP" PP			PP" PP			PP" PP		