

7UHQFK 026 %DUULHU 6FKRWWN\ 5H

‡ \$GYDQWUHQFK WHFKQRORJ\  
‡ /RZRUZDWRGWDJH GURS  
‡ /RZRZURVVHV  
‡ +LJHILFLHQF\ RSHUDWLRO  
‡ /HDGH)HLQLVK &RPSOLDQW

‡ '& &RQYHUWHUV  
‡ \$& GDSWRUV  
‡ 6ZFRZDSSOLHV  
‡ )UHZKHHLGQJ

3DUDPHWHU	6\PERO	/LPLW	8QLW
0D[LPXPHSHVSHUNYHYURQHW DJH	9550		9
0D[LPXPHYHURZDUG UFXEWHIQWG	,) \$9		\$

3HDN IRUZDWRUWHU VLQDQHWZDYH  
VXSHULPSUNYHQD G

1RWHV

3XOVH WHVVSXOVH ZLGWK GXW\ F\FOH

3XOVH WHVW 3XOVH ZLGWK 0

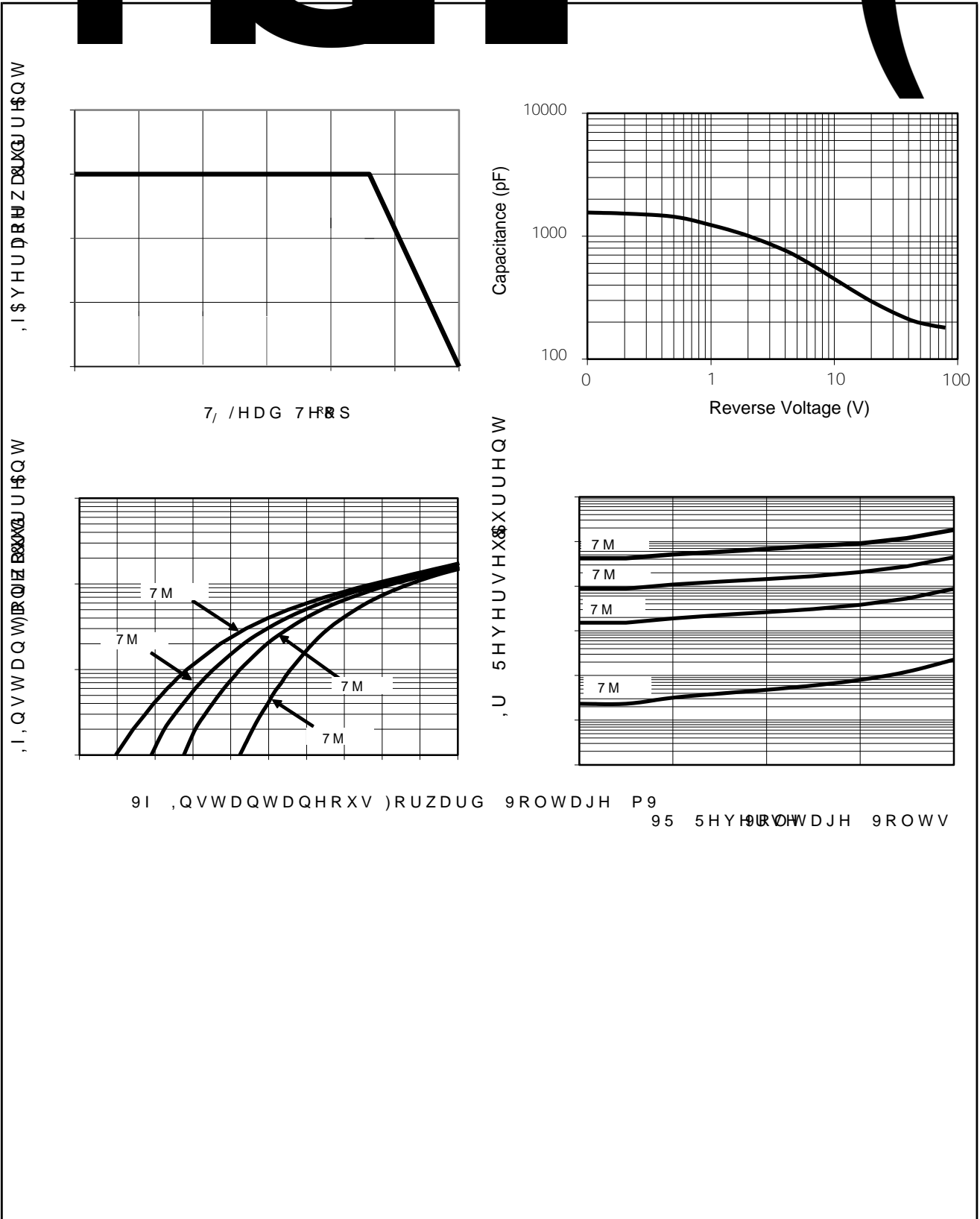

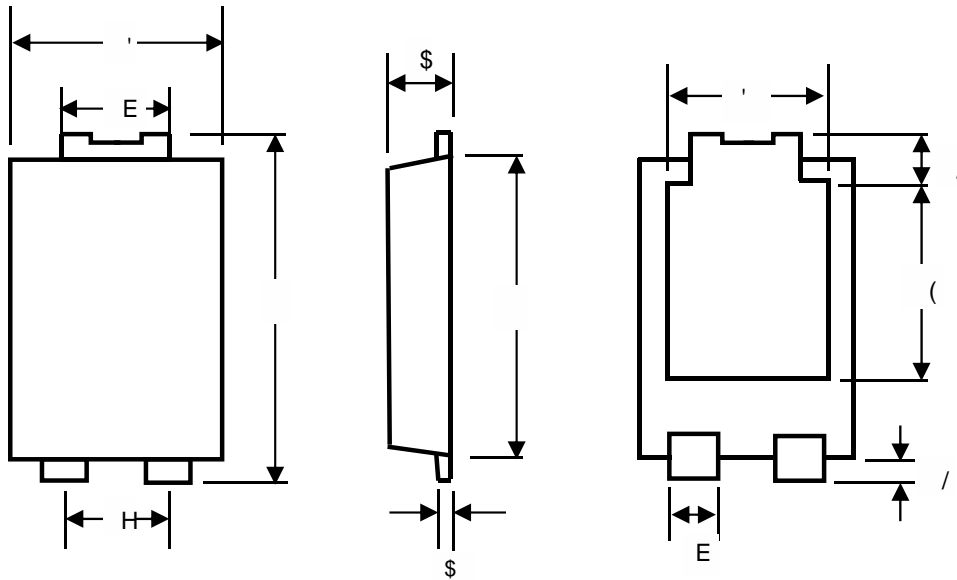
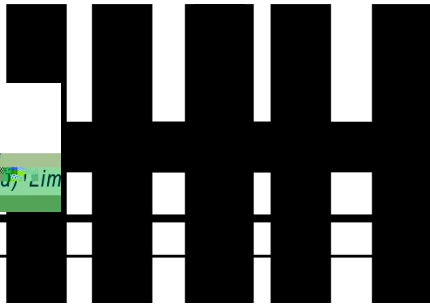

81,7		\$	\$	E	E	'	'	(	(	(	/	/
PP	PD[											
	PLQ											
PLO	PD[											
	PLQ											

72

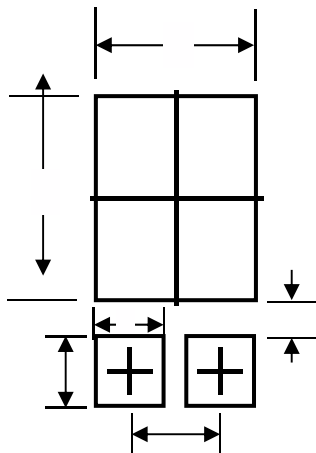

81,7		&	*	;	;		
PP	PLQ						
PLO	PLQ						

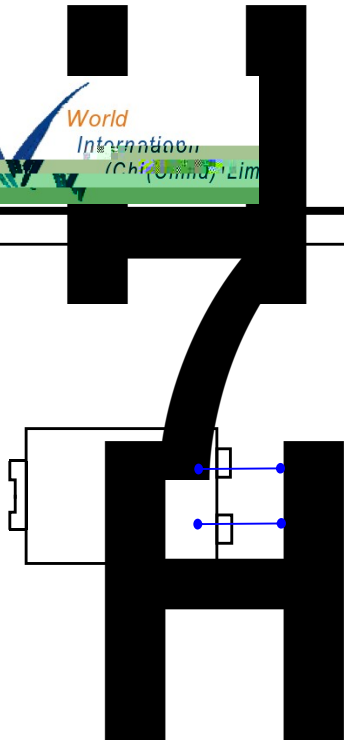

3URGXFV PRGHO 76315L80SPG  
WR DV 15L80  
3' & LQIRUPDWLRQ

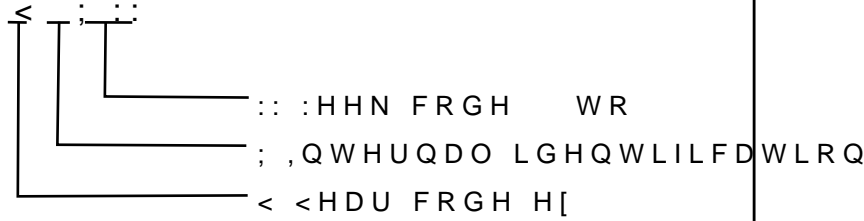

5HHO 'LPHQVLRQV

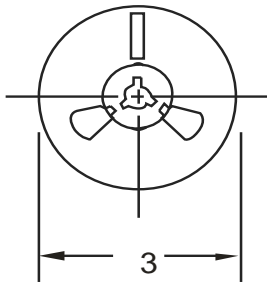

,QVLGH %R[

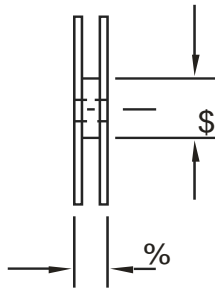

2XWVLGH %R[

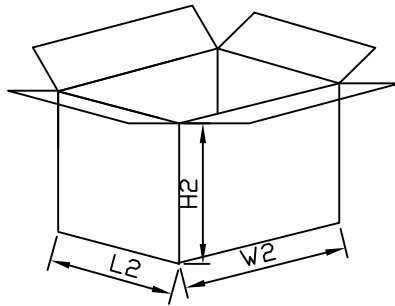
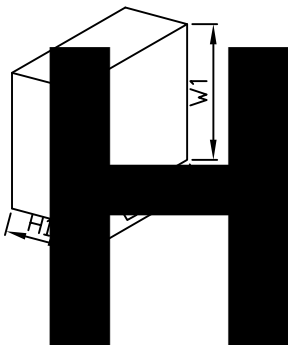

12	81,7	5HH'OPHQVLRQV	,QVLGH	2XWVLGH %R[
6L]H	PP	\$ %	/ : +	/ : +
47<	3&6	6PDOOHVW SDFNDJH	3&6 UHHO	3&6 UHHO
1RWH		7ROHUDQFPP" PP	PP" PP	PP" PP