

06% (

06% (

0\$5

6SHFLDO)RU '& \$& 5HFWLILHU %U



06% 3DFNDJH

3,11,1*

3,1	'(6&5,37,21
	,QSXWÄÄ Q
	,QSXWÄÄ Q
	2XWSXWÄÄ QRGH
	2XWSXWÄÄ WKRGH

)HDWXUHV

‡*ODV DVVLY &KWLK FWLRQ

‡5HYHUVH 9ROWDJH 9

‡)RUZDUG XUHQW \$

‡+LJXU &XUUHQW DELOLW\

‡'HVLJQHGXURDGH \$SOLFDFWLRQ

%HQHILWV

‡&DVH6%

‡7HUPLGRGHUOH7'

‡5HGXFHG SRZHU ORVV DQG VZLW

WUDQVVLWRU

0D[LPXP DWLQGHFWKDDOFWHULVWLFV

5DWLQV &DPELGHVSHUXDUMKHU\SLHFLILHG

6LQJOH SKDVH KQIHZDYLQYGHFORRDSDFLWEXHURDGH

3DUDPHWHU	6\PEROV06% (06% (8QLWV
0D[LPXP 5SHWLWLYH 3HDN 5950U VH 9ROWDJH	9506		9
0D[LPXP 506 YROWDJH	9506		9
0D[LPXP '& %ORFNLQJ 9ROWDJH &			9
\$YHUDJH 5HFWLILHG 2XWSXW &RUUHQW			\$
5HYHUVH 5HFRYHU\ 7LPH ,) \$,5 \$,55 \$	7UU		QV
3HDN)RUZDUG 6XUJH &XUUHQW +DOI 6LQH :DYH 6XSHULPSRV, H60 RQ 5DWHG /RDG -('(& 0HWKRG		PV 6LQJOH RQ 5DWHG	\$
, WUDWROXVLQBV W PV	, W		\$ 6
0D[LPXP)RUZDUG 9ROWDJH DQ)			9
0D[LPXP '& 5HYHUVH &XUUHQW #7\$ DW 5DWHG '& %ORFNLQJ 9ROWDJH #7\$	f &	f &	\$
7\SLFDO -XQFWLRQ &RVSDFLWD &FH			S)
2SHUDWLQJ DQG 6WRUDJH 7HPSWWDWXUH 5DQJH a			f &
7\SLFDOXUHFDQVWIRQVHH	5W & 5W &		f & :

1RWH0HDVXD MG+]DQGS SOLLHYGHURDWRDJH&

7KHUPDO UHVLVWDQFH IURP -XQFWLRQ WR FDVH OHDG DQG DPELHQW I
PP PP PP \$/SDG DWWDFK PP PP PP VWHHO SODWH

06% (06% (5HY

:RUOG ,QWH&QLDMLFLQDGHG

06% ()
 06% ()
 0\$5

3\$&.\$*(287/,1(' ,0(16,216

06%

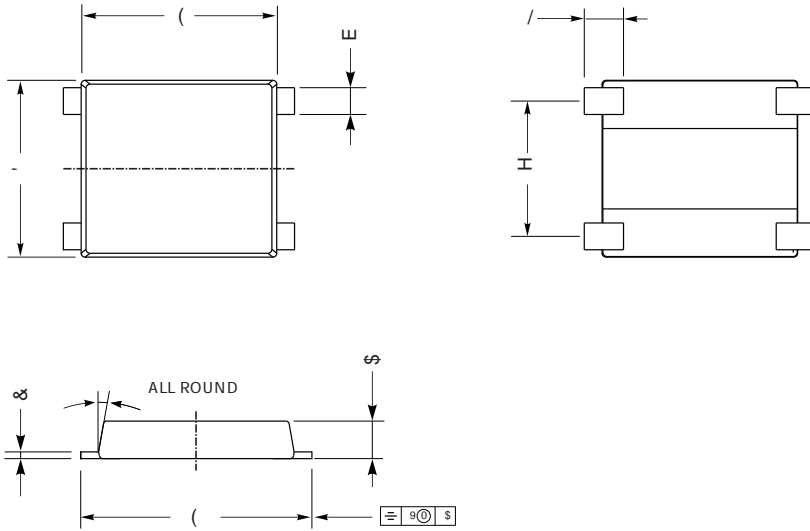

06%PHFKDGLFWO

81,7		\$	&	'	((/	H	E	
PP	PD[f
	PLQ									
PLO	PD[
	PLQ									

06%6XJJHVWHG 3DG /D\RXW

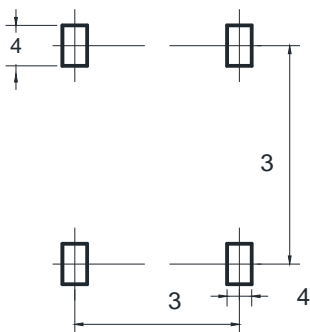

81,7		3	3	4	4
PP	PLQ				
PLO	PLQ				

'LPHQVILR/QP/LOOLPHWHUV

06% () 06% () 5HY

:RUOG ,QWH&JQLDQ/LFRQDHO

06% (

06% (

0\$5

0DUNLQJ ,QIRUPDWLRQ

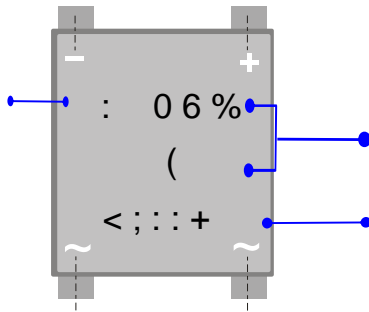

7&RPSDQ\ %UDQG :

83URGXFW PRGHO 06% (RU 06%

93'& LQIRUPDWLRQ

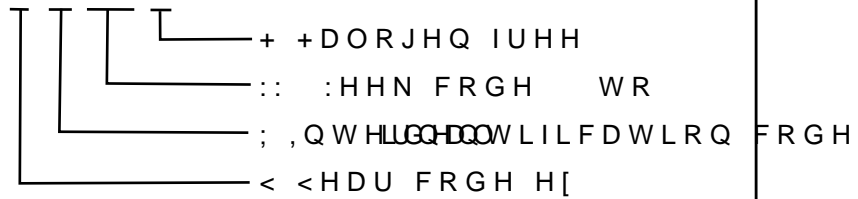

3DFNDJLQJ ,QIRUPDWLRQ

5HHO 'LPHQVLRQV

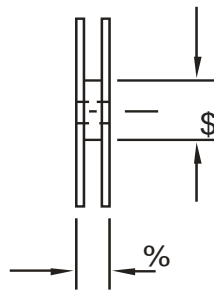
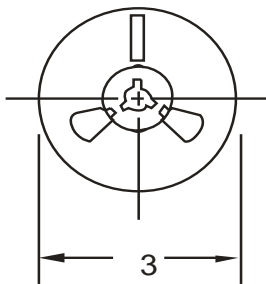

,QVLGH %R[

2XWVLGH %R[

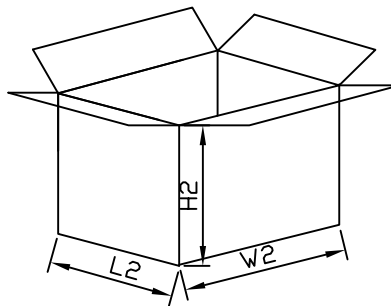
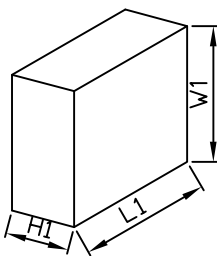

3DFNDJLQJ ,QIRUPDWLRQ

12	81,	5HHO 'LPHQVLR			,QVLGH %R[2XWVLGH %R[
		\$	\$	%	/	:	+	/	:	+
6L]H	PP									
47<	3&6	6PDOGDFW DJH3&6 UHHO			3&6 UHHO RWDO			3&6 FDUERLQ RWDO		
1RWH		7ROHUDQFH PP" PP			PP" PP			PP" PP		