



: 5 / 6 % 0

8OWUDVRIW 5HFRYHU\ %ULGJH



3,11,1\* /6% 3DFNDJH

3,1	'(6&5,37,21
	,Q SXVÄ 3Ä Q
	,Q SXVÄ 3Ä Q
	2XWSXW \$ QÄ RGH
	2XWSXW &Ä WKRGH

) HDWXUHV  
 ‡\*ODV DVVLY &KLSG FWLRQ  
 ‡5HYHURDWDJH9  
 ‡)RUZDUGUHSW  
 ‡+LJXU &XUUHQSD ELOLW\  
 ‡'HVLJQRG XUIDRHS \$S SOLFDWLRQ

%HQHILWV  
 ‡&DVH %  
 ‡7HUPLGRG HGBH 0H7'  
 ‡5HGXFHG (0, 5HGXFHG SRZHU  
 DQG VZLWFKLQJ WUDQVLYW

0D[LPXP DWLQ QG OHFWERK BDO FWHULVWLFV

5DWLQV &PEL MGHV SHUXDQXUMK HUZLHFLILHG  
 6LQJOH SKDVH KQIHZD VMLQYGH FORVGH DSDFLWEXH UGRDWH

3DUDPHWHU	6\PEROV	:5/6% 0	8QLWV
0D[LPXP 5HSHWLWLYH 3HDN 5950U	VH 9ROWDJH		9
0D[LPXP 506 YROWDJH	9506		9
0D[LPXP '& %ORFNLQJ 9ROWDJH &			9
\$YHUDJH 5HFWLILHG 2XWSXW &RUUHQW			\$
5HYHUVH 5HFRYHU\ 7LPH ,) \$ ,5 \$ ,55 \$	7UU		XV
3HDN )RUZDUG 6XUJH &XUUHQW +DOI 6LQH :DYH 6XSHULPSRV, HGO RQ 5DWHG /RDG -('(& 0HWKRG		PV 6LQJOH RQ 5DWHG	\$
, WUDWROXVLQRV W PV	, W		\$ 6
0D[LPX)RUZDUG WDW H\$	9)		9
0D[LPXP '& 5HYHUVH &XUUHQW #7\$ DW 5DWHG '& %ORFNLQJ 9ROWDJH #7\$	f & f &		\$
7\SLFDO -XQFWLRQ &RDSDFLWD &MH			S)
2SHUDWLQJ DQG 6WRUDJH 7HPSW WDWXUH 5DQJH a			f &
7\SLFDO WKHUPDO UHVLVWDQJ 5WK 1\$ 5WK 1\$			f & :
1RWH0HDVX DWG+]DQGSSOLLHGHYURQWRD JH& 0RXQWHG RQ JODVV HSR[\ 3& ERDUG ZLWFRSSHU SDG			

---

**RATINGS AND CHARACTERISTICS CURVES** 7\$ ° & XQOHVV RWKHUZZLVH QRWHG

---

7 F & DVH 7&HPS

3 \$ & . \$ \* ( 287 / , 1 ( ' , 0 ( 16 , 2 16

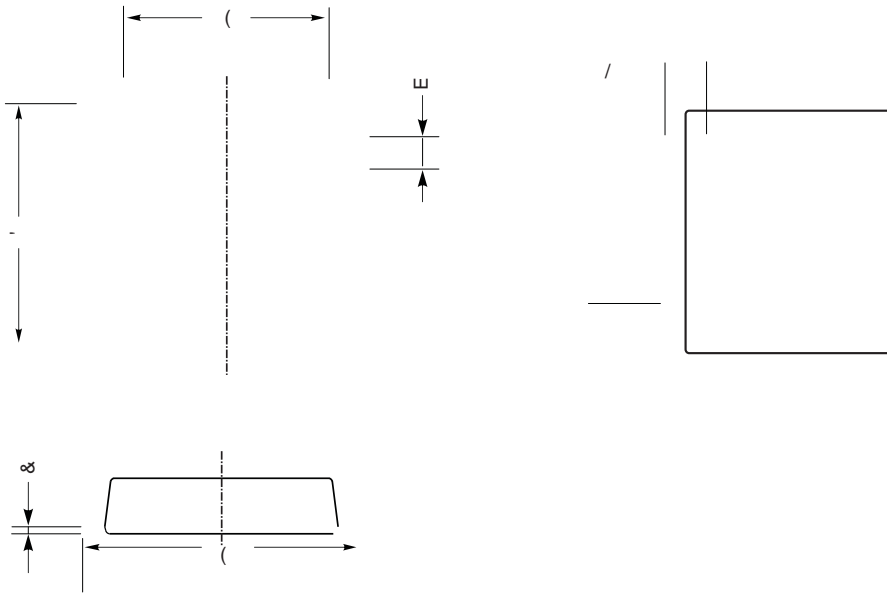

/ 6 % P H F K D Q G L F W D

8 1 , 7		\$	&	'	(	&	/	H	E
PP	PD[								
	PLQ								
PLO	PD[								
	PLQ								

/ 6 % 6 X J J H V W H G 3 D G / D \ R X W

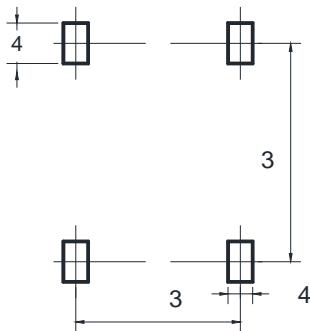

8 1 , 7	3	3	4	4
PP	PLQ			
PLO	PLQ			

' L P H Q V I L R / Q R / L O O L P H W H U V



: 5 / 6 % 0

0DUNLQJ ,QIRUPDWLRQ

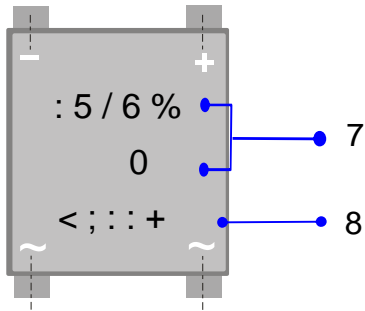

73URGXFW P5R 6% 00  
83' & LQIRUPDWLRQ

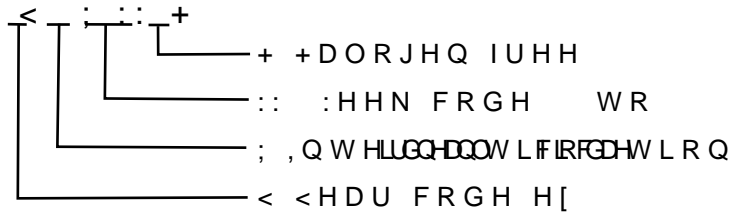

3DFNDJLQJ ,QIRUPDWLRQ

5HHO 'LPHQVLRQV

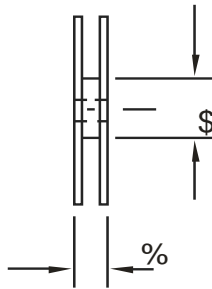
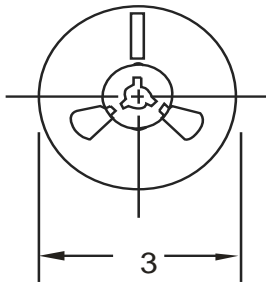

,QVLGH %R[

2XWVLGH %R[

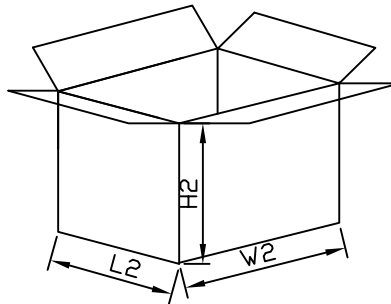
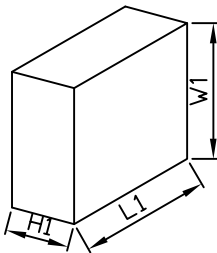

3DFNDJLQJ ,QIRUPDWLRQ

12	81,	5HHO 'LPHQVLR			,QVLGH %R[			2XWVLGH %R[		
6L]H	PP	&	\$	%	/	:	+	/	:	+
47<	3&6	6PDOGDVFDJH3&6 UHHO			3&6 UHHO RWDO			3&6 FDUERDWRDO		
1RWH		7ROHUDQFPP" PP			PP" PP			PP" PP		